

# Service Data Sheet

## Issue 9 - 12.2012

This document is protected by copyright and may not, in whole or part be stored in a retrieval system, or transmitted in any form or by any means, copied, photocopied, translated or reduced to any machine-readable form without prior consent in writing from Triumph Motorcycles Limited.

No liability can be accepted for any inaccuracies or omissions in this publication, although every possible care has been taken to make it as complete and accurate as possible.

Triumph Motorcycles Limited reserves the right to make changes and alter specifications without prior notice and without incurring an obligation to make such changes to products manufactured previously. See your authorised Triumph dealer for the latest information on product improvements incorporated after this publication.

All information contained in this publication is based on the latest product information available at the time of publication. Illustrations in this publication are intended for reference use only and may not depict actual model component parts.

© Triumph Motorcycles Ltd. 2012

# SERVICE DATA SHEET

## Tiger 800/800XC

### Brakes

- Brake disc maximum run out. . . . . 0.5 mm (front and rear)
- Brake disc minimum thickness. . . . . Front 4.0 mm - Rear 5.5 mm
- Brake fluid. . . . . DOT 4

### Master Cylinders

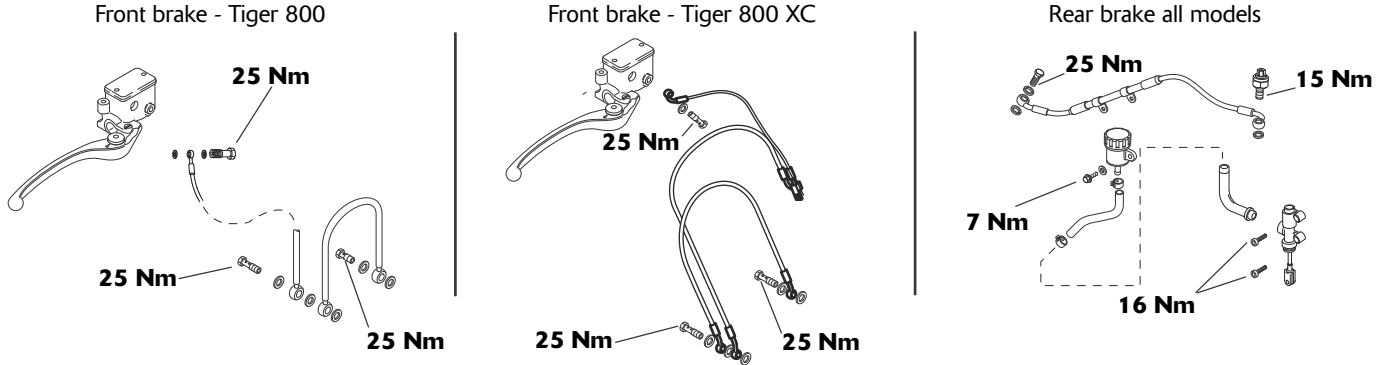

### Calipers and Brake Pads

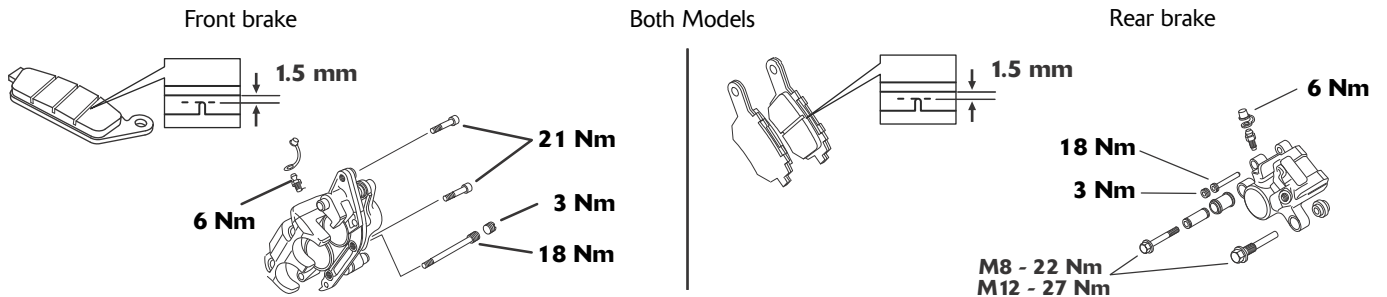

### Engine and Lubrication

- Oil. . . . . Semi or fully synthetic 10W/40 or 10W/50 engine oil which meets specification API SH (or higher) and JASO MA. Triumph recommends Castrol Power 1 Racing 4T 10W/40 or 10W/50 (fully synthetic) engine oil, sold as Castrol Power RS Racing 4T 10W/40 or 10W/50 (fully synthetic) in some countries
- Oil quantity. . . . . 3.6 litres (oil and filter change). Always refer to the check sight glass for the correct level
- Coolant type. . . . . Triumph HD4X Hybrid OAT coolant (premixed as supplied by Triumph)
- Coolant capacity. . . . . 2.4 litres
- Grease. . . . . Grease to NLGI 2 specification
- Camshaft cover bolts. . . . . Lubricate the seals for the camshaft cover bolts with clean engine oil
- Camshaft cover tightening sequence. . . . . Tighten the camshaft cover bolts in the sequence shown below

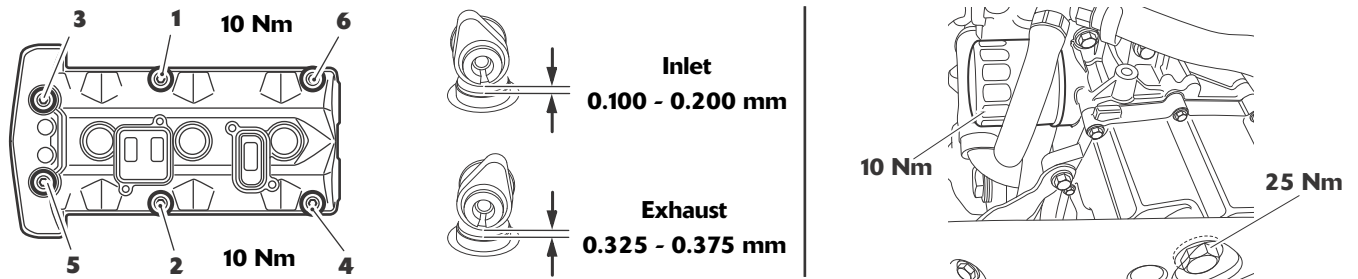

### Fuel and Air

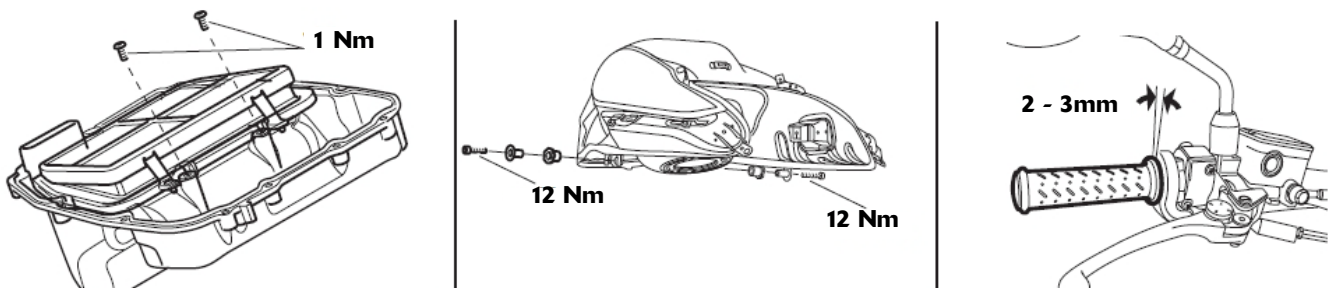

# SERVICE DATA SHEET - continued

## Final Drive and Clutch

Chain lubrication..... Chain spray suitable for O-ring chains

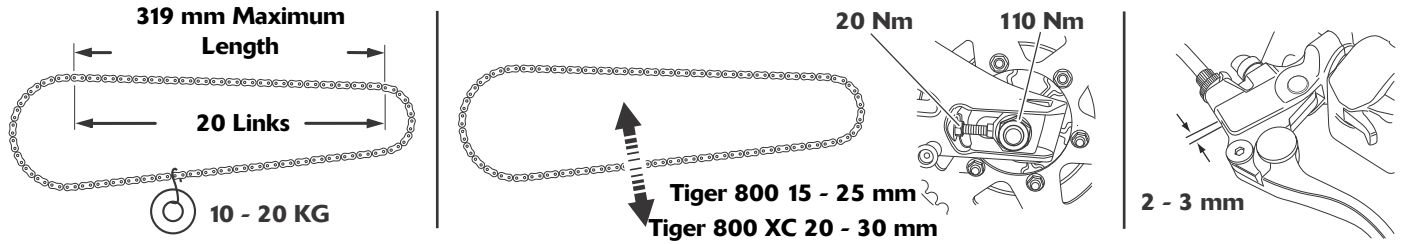

## Battery and Ignition

Charge rate ..... Must not exceed 1.4A (refer to the service manual)

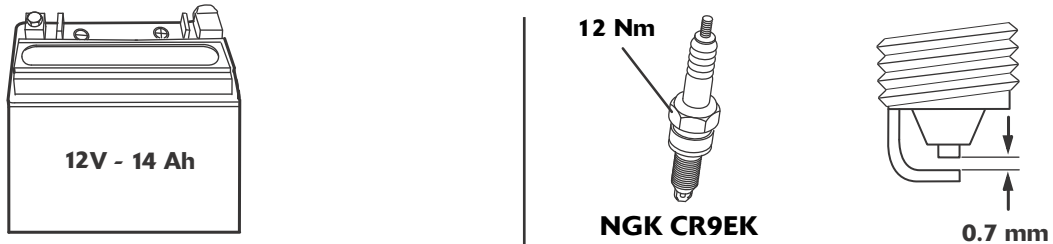

## Suspension and Wheels

	Tiger 800	Tiger 800XC
Recommended fork oil grade	Showa SS8 (SAE10W)	
Oil volume (dry fill)	553 cc	484 cc
Oil level (fork fully compressed)	103 mm	107 mm

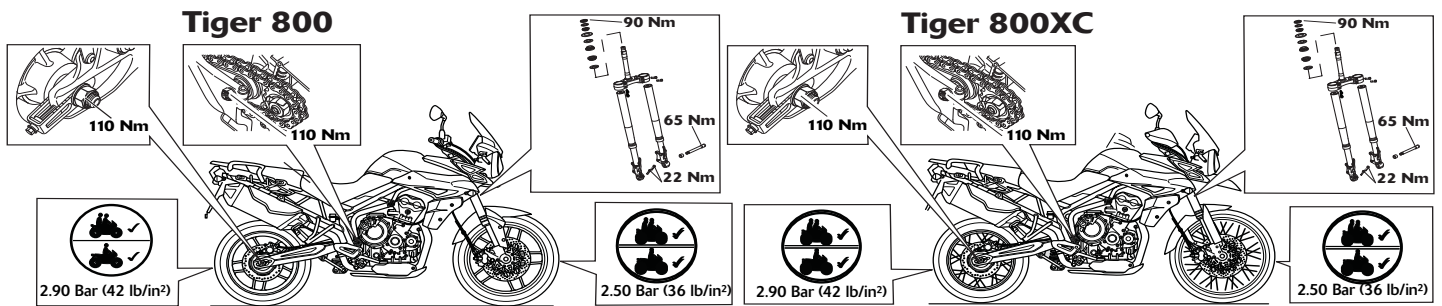

Tyre Pressure (Off Road Use Only)

Refer to the owners manual

## Service Parts Information

Part Number	Description	Odometer Reading in Miles (kms), Time Period				
		500/ 1 month (800) Annual	6,000 (10,000)	12,000 (20,000)	18,000 (30,000)	24,000 (40,000)
T3550605	Sump Plug Washer	.	.	.	.	.
T1210444	Oil Filter	.	.	.	.	.
T2200557	Air Cleaner			.		.
T1290023	Spark Plug			.		.
T1261309	Camshaft Cover Seal			.		.
T1260309	Camshaft Cover Screw Seal			.		.
T2020377	Front Brake Pad Set - Tiger 800	As necessary				
T2020602	Rear Brake Pad Set	As necessary				